

DEPARTMENT OF THE ARMY PERMIT

Permittee: Harbour Waterway Association
4636 Harbour North Court
Jacksonville, Florida 32225

Permit No: SAJ-1993-1030-PRJ

Issuing Office: U.S. Army Engineer District, Jacksonville

NOTE: The term "you" and its derivatives, as used in this permit, means the permittee or any future transferee. The term "this office" refers to the appropriate district or division office of the Corps of Engineers having jurisdiction over the permitted activity or the appropriate official of that office acting under the authority of the commanding officer.

You are authorized to perform work in accordance with the terms and conditions specified below.

Project Description: The permittee is granted a 10-year Department of the Army permit to hydraulically dredge 60,000 cubic yards of material from a residential canal in Mill Cove. The canal would be excavated to a depth of -5 feet Mean Low Water (MLW) as depicted in the attached project drawings. The dredge material would be deposited at a designated upland spoil disposal site. The applicant also requests after the fact authorization for the existing breakwater and the applicant proposes to install signs on the existing break water. The existing breakwater is 1500 feet in length as depicted in the attached project drawings. The work described above is to be completed in accordance with the 11 pages of drawings affixed at the end of this permit instrument.

Project Location: The project is located in an existing canal in Mill Cove that runs in between the Harbour Island Subdivision and the Harbour North Subdivision, in Sections 32 and 50, Township 1 South, Range 28 East, Jacksonville, Duval County, Florida.

Directions to site: From downtown Jacksonville take the Arlington Expressway/Matthews Bridge East to the Southside Connector/SR-113 North. Then take the Merrill Road exit and turn right to follow SR-116 East which turns into Fort Caroline Road. Turn left from SR-116 to follow Fort Caroline Road. Continue to follow Fort Caroline Road going north until you reach Harbour Cove Drive South. Turn left onto Harbour Cove Drive South and follow Harbour Cove Drive to Harbour Woods Road South. Turn left onto Harbour Woods Road South and follow to Harbour Island Drive. The proposed work is in the canal in the residential subdivision.

Latitude & Longitude: Latitude: 30.380368° North
Longitude: 81.519068° West

PERMIT NUMBER: SAJ-1993-1030 (SP-PRJ)
PERMITTEE: Harbour Waterway Association
PAGE 2 of 9

Permit Conditions

General Conditions:

1. The time limit for completing the work authorized ends on **December 28, 2022**. If you find that you need more time to complete the authorized activity, submit your request for a time extension to this office for consideration at least one month before the above date is reached.

2. You must maintain the activity authorized by this permit in good condition and in conformance with the terms and conditions of this permit. You are not relieved of this requirement if you abandon the permitted activity, although you may make a good faith transfer to a third party in compliance with General Condition 4 below. Should you wish to cease to maintain the authorized activity or should you desire to abandon it without a good faith transfer, you must obtain a modification of this permit from this office, which may require restoration of the area.

3. If you discover any previously unknown historic or archeological remains while accomplishing the activity authorized by this permit, you must immediately notify this office of what you have found. We will initiate the Federal and State coordination required to determine if the remains warrant a recovery effort or if the site is eligible for listing in the National Register of Historic Places.

4. If you sell the property associated with this permit, you must obtain the signature and the mailing address of the new owner in the space provided and forward a copy of the permit to this office to validate the transfer of this authorization.

5. If a conditioned water quality certification has been issued for your project, you must comply with the conditions specified in the certification as special conditions to this permit. For your convenience, a copy of the certification is attached if it contains such conditions.

6. You must allow representatives from this office to inspect the authorized activity at any time deemed necessary to ensure that it is being or has been accomplished in accordance with the terms and conditions of your permit.

Special Conditions:

1. **Reporting Address:** All reports, documentation and correspondence required by the conditions of this permit shall be submitted to the following address: U.S. Army Corps of Engineers, Regulatory Division, Enforcement Section, P.O. Box 4970, Jacksonville, FL 32232. The Permittee shall reference this permit number, SAJ-1993-1030-PRJ, on all submittals.

PERMIT NUMBER: SAJ-1993-1030 (SP-PRJ)
PERMITTEE: Harbour Waterway Association
PAGE 3 of 9

2. **Manatee Conditions:** The Permittee shall comply with the “Standard Manatee Conditions for In-Water Work – 2011” (attached).
3. **Dedicated Manatee Observer:** The Permittee shall have one dedicated manatee observer on the project site during all in-water work between the months of March through November.
4. **In-Water Work Restrictions:** The Permittee shall restrict all in-water work to the hours between one-half hour after sunrise to one-half hour before sunset.
5. **Placement of Pipeline:** The Permittee shall ensure that the dredge pipeline is used in a way that it will not impede the manatee.
6. **Manatee Information Signs:** The permittee shall install two “Caution – Boaters” manatee information signs as described on the Florida Fish and Wildlife Conservation Commission’s website, http://www.myfwc.com/media/415211/Manatee_EducationalSign.pdf, and developed in accordance with the requirements of Chapter 68D-23, Uniform Waterway Markers in Florida Waters, of the State of Florida (<http://myfwc.com/media/1411288/68D-23.pdf>). One sign shall be affixed to the eastern end of the northern breakwater facing the entrance canal, while the second sign shall be affixed to the southern breakwater at its western end in a manner that makes it readily visible to incoming boat traffic.
7. **Self-Certification:** Within 60 days of completion of the authorized work or at the expiration of the construction window of this permit, whichever occurs first, the Permittee shall complete the attached “Self-Certification Statement of Compliance” form (attached) and submit to the Corps. In the event that the completed work deviates, in any manner, from the authorized work, the Permittee shall describe, on the Self-Certification Form, the deviations between the work authorized by the permit and the work as constructed. Please note that the description of any deviations on the Self-Certification Form does not constitute approval of any deviations by the Corps.
8. **Assurance of Navigation and Maintenance:** The Permittee understands and agrees that, if future operations by the United States require the removal, relocation, or other alteration, of the structures or work herein authorized, or if in the opinion of the Secretary of the Army or his authorized representative, said structure or work shall cause unreasonable obstruction to the free navigation of the navigable waters, the Permittee will be required, upon due notice from the Corps of Engineers, to remove, relocate, or alter the structural work or obstructions caused thereby, without expense to the United States. No claim shall be made against the United States on account of any such removal or alteration.
9. **Historic Properties:**
 - a. No structure or work shall adversely affect or disturb properties listed in the National Register of Historic Places or those eligible for inclusion in the National Register. Prior to the

PERMIT NUMBER: SAJ-1993-1030 (SP-PRJ)
PERMITTEE: Harbour Waterway Association
PAGE 4 of 9

start of work, the Permittee or other party on the Permittee's behalf, shall conduct a search in the National Register Information System (NRIS). Information can be found at; <http://www.cr.nps.gov/nr/research>. Information on properties eligible for inclusion in the National Register can be identified by contacting the Florida Master File Office by email at fmsfile@dos.state.fl.us or by telephone at 850-245-6440.

b. If unexpected cultural resources are encountered at any time within the project area that was not the subject of a previous cultural resource assessment survey, work should cease in the immediate vicinity of such discoveries. The permittee, or other party, should notify the SHPO immediately, as well as the appropriate Army Corps of Engineers office. After such notifications, project activities should not resume without verbal and/or written authorization from the SHPO.

c. If unmarked human remains are encountered, all work shall stop immediately, and the proper authorities notified in accordance with Section 872.05, Florida Statutes, unless on Federal lands. After such notifications, project activities on non-Federal lands shall not resume without verbal and/or written authorization from the Florida State Archaeologist for finds under his or her jurisdiction.

Further Information:

1. Congressional Authorities: You have been authorized to undertake the activity described above pursuant to:

Section 10 of the Rivers and Harbors Act of 1899
(33 U.S.C. 403).

Section 404 of the Clean Water Act (33 U.S.C. 1344).

Section 103 of the Marine Protection, Research and Sanctuaries Act of 1972 (33 U.S.C. 1413).

2. Limits of this authorization.

a. This permit does not obviate the need to obtain other Federal, State, or local authorizations required by law.

b. This permit does not grant any property rights or exclusive privileges.

c. This permit does not authorize any injury to the property or rights of others.

PERMIT NUMBER: SAJ-1993-1030 (SP-PRJ)
PERMITTEE: Harbour Waterway Association
PAGE 5 of 9

d. This permit does not authorize interference with any existing or proposed Federal projects.

3. Limits of Federal Liability. In issuing this permit, the Federal Government does not assume any liability for the following:

a. Damages to the permitted project or uses thereof as a result of other permitted or unpermitted activities or from natural causes.

b. Damages to the permitted project or uses thereof as a result of current or future activities undertaken by or on behalf of the United States in the public interest.

c. Damages to persons, property, or to other permitted or unpermitted activities or structures caused by the activity authorized by this permit.

d. Design or construction deficiencies associated with the permitted work.

e. Damage claims associated with any future modification, suspension, or revocation of this permit.

4. Reliance on Applicant's Data: The determination of this office that issuance of this permit is not contrary to the public interest was made in reliance on the information you provided.

5. Reevaluation of Permit Decision: This office may reevaluate its decision on this permit at any time the circumstances warrant. Circumstances that could require a reevaluation include, but are not limited to, the following:

a. You fail to comply with the terms and conditions of this permit.

b. The information provided by you in support of your permit application proves to have been false, incomplete, or inaccurate (see 4 above).

c. Significant new information surfaces which this office did not consider in reaching the original public interest decision.

Such a reevaluation may result in a determination that it is appropriate to use the suspension, modification, and revocation procedures contained in 33 CFR 325.7 or enforcement procedures such as those contained in 33 CFR 326.4 and 326.5. The referenced enforcement procedures provide for the issuance of an administrative order requiring you comply with the terms and conditions of your permit and for the initiation of legal action where appropriate. You will be

PERMIT NUMBER: SAJ-1993-1030 (SP-PRJ)
PERMITTEE: Harbour Waterway Association
PAGE 6 of 9

required to pay for any corrective measures ordered by this office, and if you fail to comply with such directive, this office may in certain situations (such as those specified in 33 CFR 209.170) accomplish the corrective measures by contract or otherwise and bill you for the cost.

6. Extensions: General Condition 1 establishes a time limit for the completion of the activity authorized by this permit. Unless there are circumstances requiring either a prompt completion of the authorized activity or a reevaluation of the public interest decision, the Corps will normally give favorable consideration to a request for an extension of this time limit.

PERMIT NUMBER: SAJ-1993-1030 (SP-PRJ)
PERMITTEE: Harbour Waterway Association
PAGE 7 of 9

Your signature below, as permittee, indicates that you accept and agree to comply with the terms and conditions of this permit.



(PERMITTEE)

12-20-2012
(DATE)

William K. Hibbard

(PERMITTEE NAME-PRINTED)

This permit becomes effective when the Federal official, designated to act for the Secretary of the Army, has signed below.

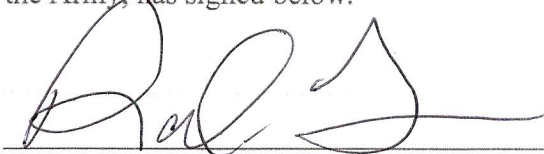

(DISTRICT ENGINEER)

12/28/2012
(DATE)

Alan M. Dodd
Colonel, U. S. Army
District Commander

PERMIT NUMBER: SAJ-1993-1030 (SP-PRJ)
PERMITTEE: Harbour Waterway Association
PAGE 8 of 9

When the structures or work authorized by this permit are still in existence at the time the property is transferred, the terms and conditions of this permit will continue to be binding on the new owner(s) of the property. To validate the transfer of this permit and the associated liabilities associated with compliance with its terms and conditions, have the transferee sign and date below.

(TRANSFEREE-SIGNATURE)

(DATE)

(NAME-PRINTED)

(ADDRESS)

(CITY, STATE, AND ZIP CODE)

PERMIT NUMBER: SAJ-1993-1030 (SP-PRJ)
PERMITTEE: Harbour Waterway Association
PAGE 9 of 9

*Attachments to Department of the Army
Permit Number SAJ-1993-1030-PRJ*

1. PERMIT DRAWINGS: 11 pages of permit drawings
2. STANDARD MANATEE CONDITIONS FOR IN-WATER WORK - 2011
3. SELF CERTIFICATION

Harbour Waterway Dredge
SAJ-1993-1030

On the go? Use m.bing.com to find maps, directions, businesses, and more

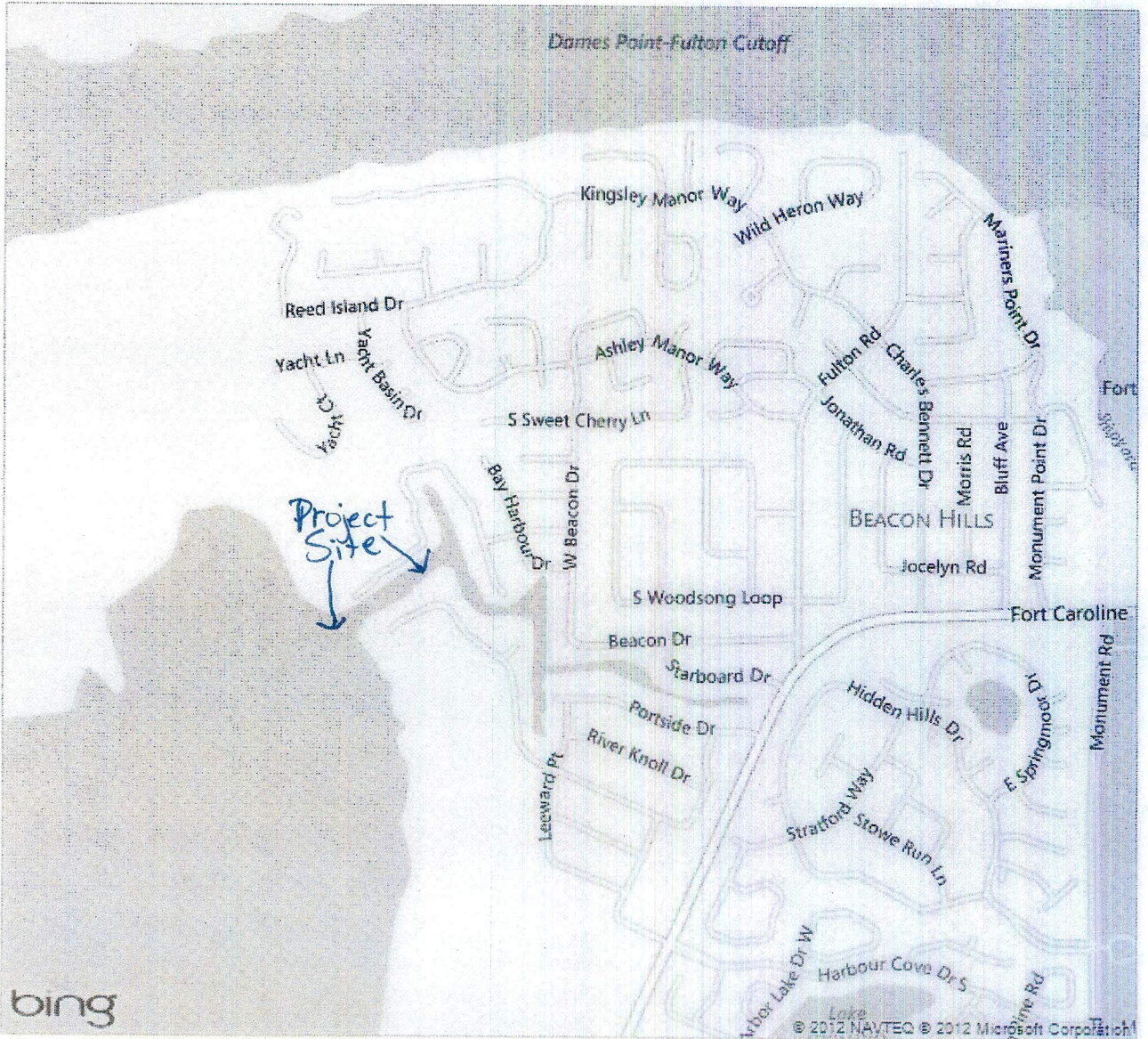
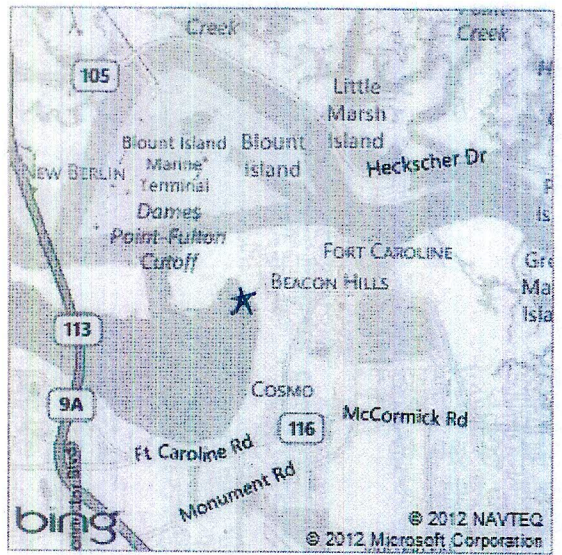

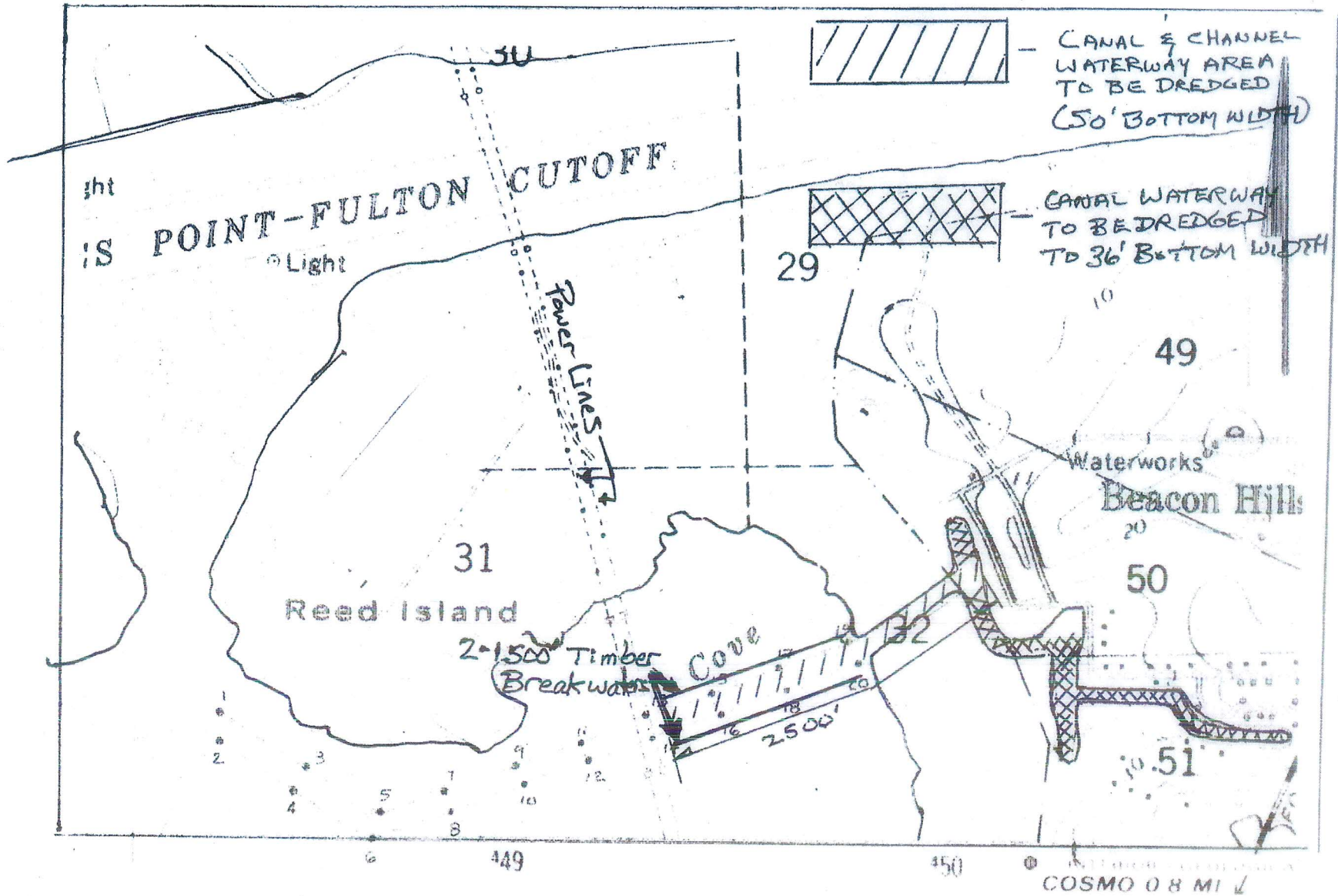

HARBOUR WATERWAY ASSOCIATION CHANNEL MARKERS
 SCALE: 1 IN = 1000 FT.

Click on sign to add text
 and place signature on a
 PDF File

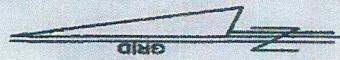

GRAPHIC SCALE
 1" = 100'

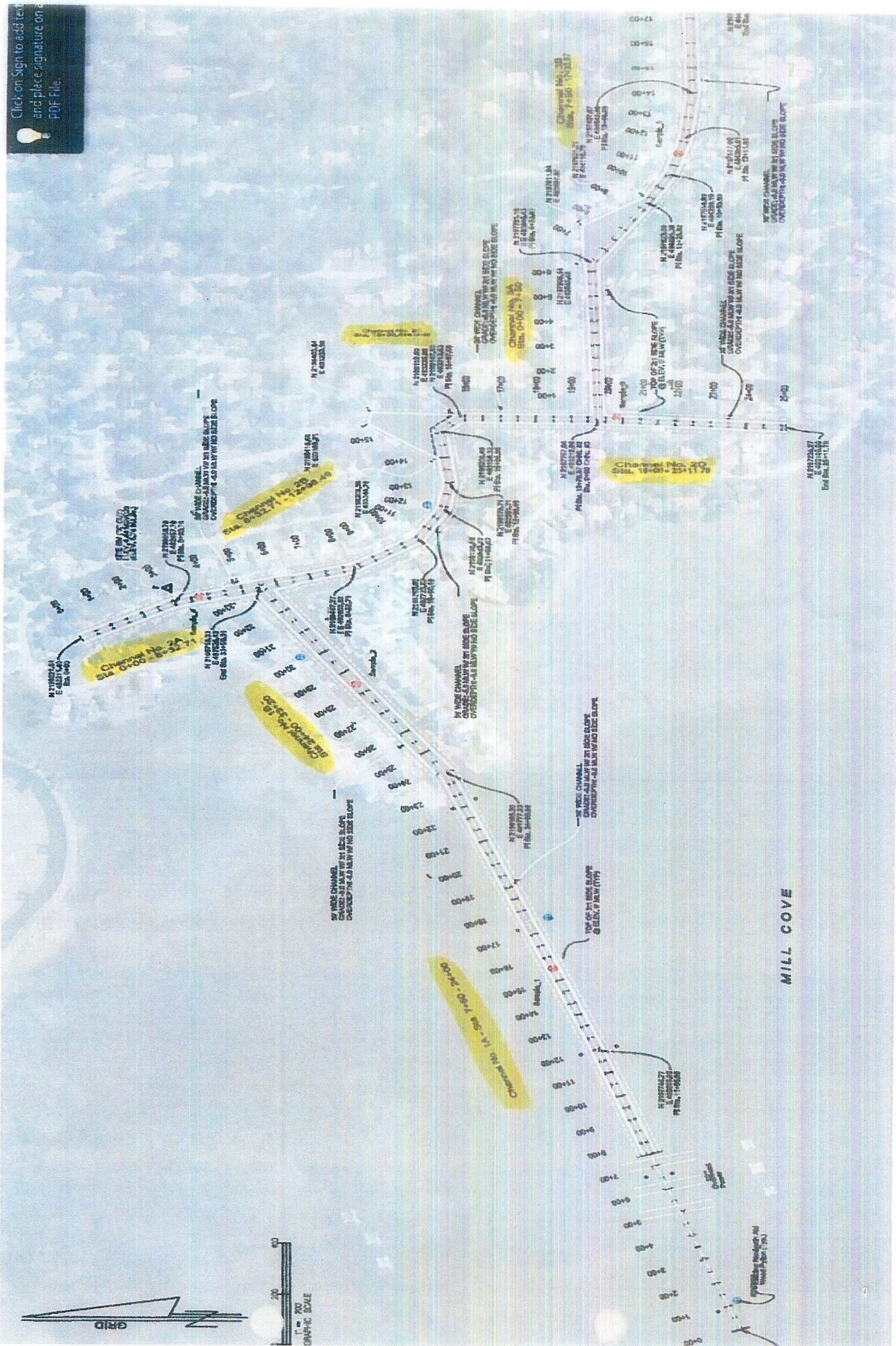

MILL COVE

50' WIDE CHANNEL
GRADE: -6.0 MLW W/ 3:1 SIDE SLOPE
OVERDEPTH: -8.0 MLW W/ NO SIDE SLOPE

36' WIDE CHANNEL
GRADE: -5.0 MLW W/ 3:
OVERDEPTH: -6.0 MLW

TOP OF 3:1 SIDE SLOPE
@ ELEV. 0' MLW (TYP)

Channel No. 1A - Sta. 7+50 - 24+00

N 2188185.20
E 481777.33
PI Sta. 24+00.86

N 2197744.77
E 490555.80
PI Sta. 11+85.95

Existing Navigatin Aid
Wood Pylon (Typ.)

N 2197330.65

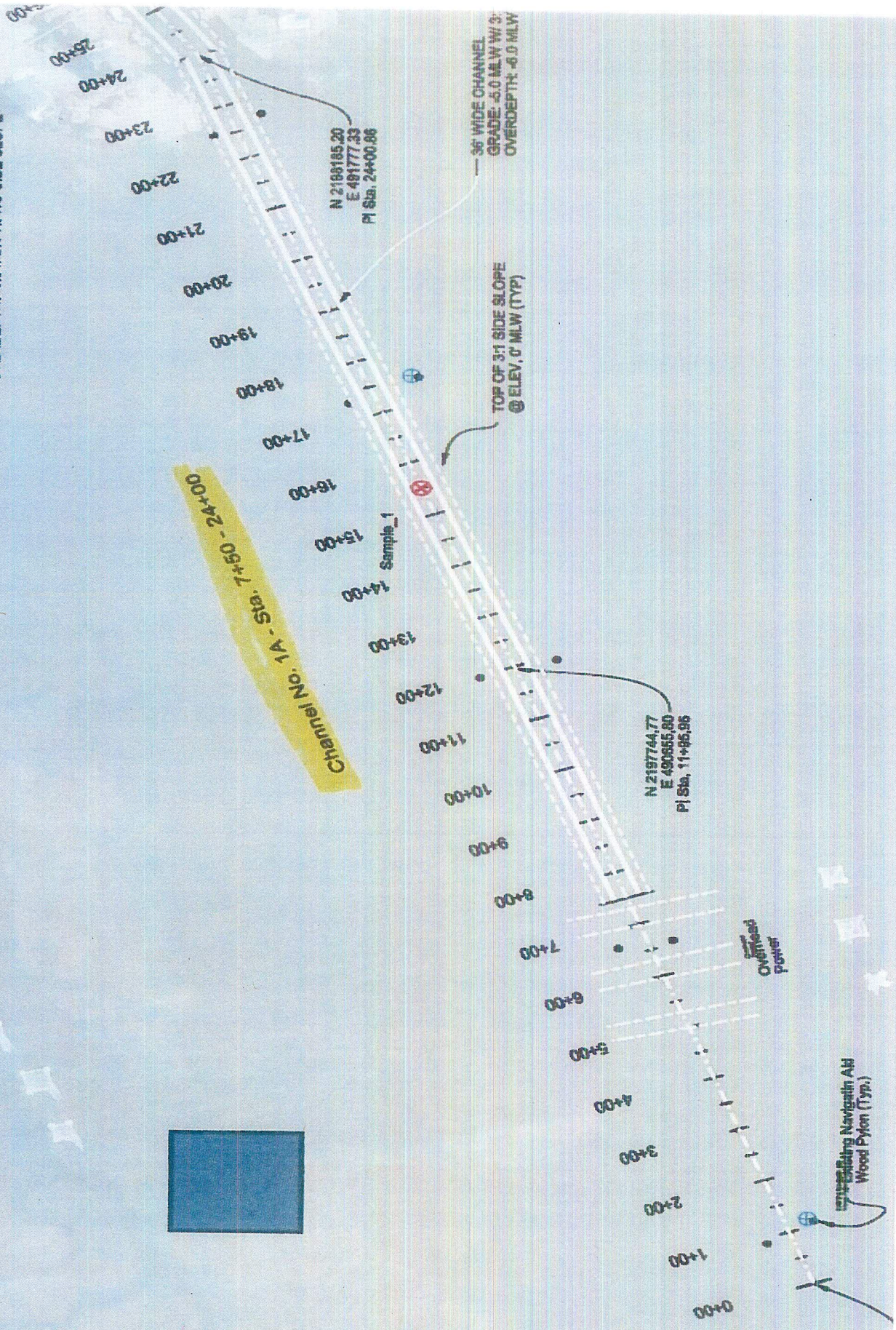

N 2199221.51
E 492311.40
Sta. 0+00

Channel No. 2A
Sta. 0+00 - 8+52.71

SITE BM ("X" CUT)
ELEV. 4.44 NGVD29
(ELEV. 5.74 M.L.W.)

N 2198958.78
E 492457.78
PI Sta. 3+00.76

N 2198718.33
E 492528.43
End Sta. 33+50.31

50' WIDE CHANNEL
GRADE: -5.0 MLW W/ 3:1 SIDE SLOPE
OVERDEPTH: -8.0 MLW W/ NO SIDE SLOPE

Channel No. 2B
Sta. 8+52.71 - 12+96.49

N 2198410.86
E 493185.21

N 2198403.64
E 493233.58

Channel No. 1B
Sta. 24+00 - 33+20

N 2198447.27
E 492603.82
PI Sta. 8+32.71

N 2198209.58
E 493046.26

Sample_2

N 2198285.80
E 492723.52
PI Sta. 10+50.10

N 2198159.90
E 493226.88
N 2198147.83
E 493213.63
PI Sta. 15+87.58

36' WIDE CHANNEL
GRADE: -5.0 MLW W/ 3:1 SIDE SLOPE
OVERDEPTH: -8.0 MLW W/ NO SIDE SLOPE

N 2198196.10

Channel No. 2C
Sta. 12+96.49 - 16+00

36' WIDE C

Channel No. 2C
Sta. 12+98.49 - 16+00

N 2199159.90
E 493228.99
N 2186147.83
E 493213.63
PI Sta. 15+67.58

36' WIDE CHANNEL
GRADE: -5.0 MLW W/ 3:1 SIDE SLOPE
OVERDEPTH: -6.0 MLW W/ NO SIDE SLOPE

Channel No. 3A
Sta. 0+00 - 7+50

N 2197761.16
E 493946.43
PI Sta. 6+33.93

N 2197808.14
E 483846.48

N 2197757.04
E 493212.96
+78.37 CHNL #2
0+00 CHNL #3

Channel No. 2D
Sta. 18+00 - 25+11.78

Sample_3

TOP OF 3:1 SIDE SLOPE
@ ELEV. 0' MLW (TYP)

36' WIDE CHANNEL
GRADE: -5.0 MLW W/ 3:1 SIDE SLOPE
OVERDEPTH: -6.0 MLW W/ NO SIDE SLOPE

N 2197823.08
E 484065.36
PI Sta. 18+28.82

N 2197568.09
E 494209.19
PI Sta. 10+69.59

36' WIDE CHANNEL
GRADE: -5.0 MLW W/ 3:1 SIDE SLOPE
OVERDEPTH: -6.0 MLW W/ NO SIDE SLOPE

N 2197517.00
E 494366.61
PI Sta. 12+11.63

N 2197811.94
E 493967.87

N 2197631.71
E 494116.70
PI Sta. 13+99.59

N 2197497.97
E 494642.40
PI Sta. 13+99.59

Channel No. 3B
Sta. 7+50 - 17+35.67

Sample_5

N 2197610.34 -
E 494925.80
End Sta. 17+83

15+00

14+00

16+00

17+00

18+00

19+00

20+00

21+00

22+00

23+00

24+00

25+00

8+00

9+00

10+00

11+00

12+00

13+00

14+00

15+00

16+00

17+00

17+83

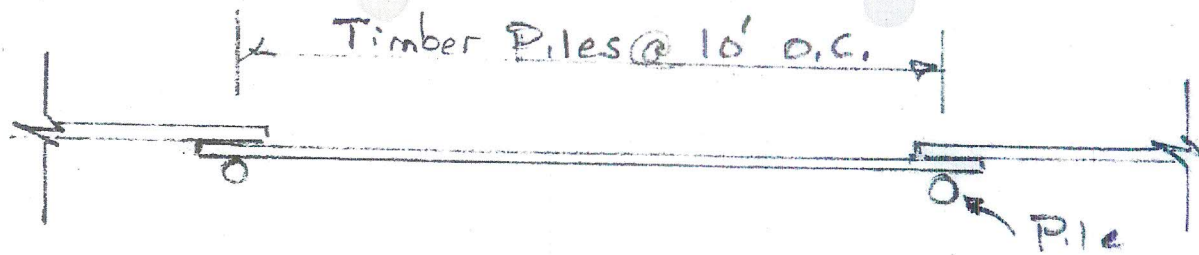

PLAN
NTS

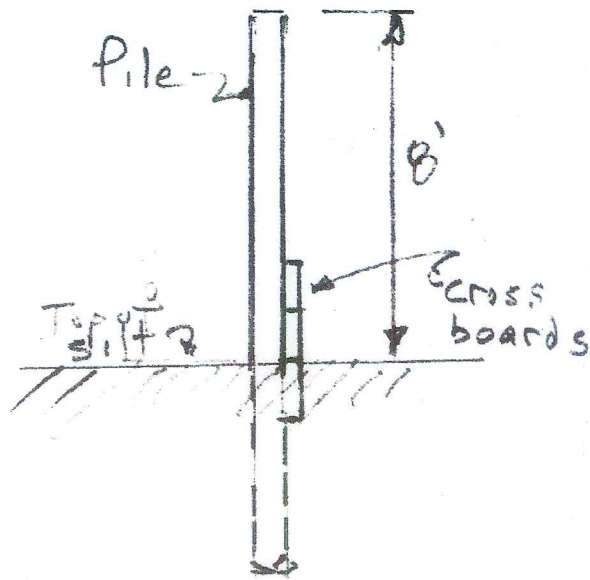
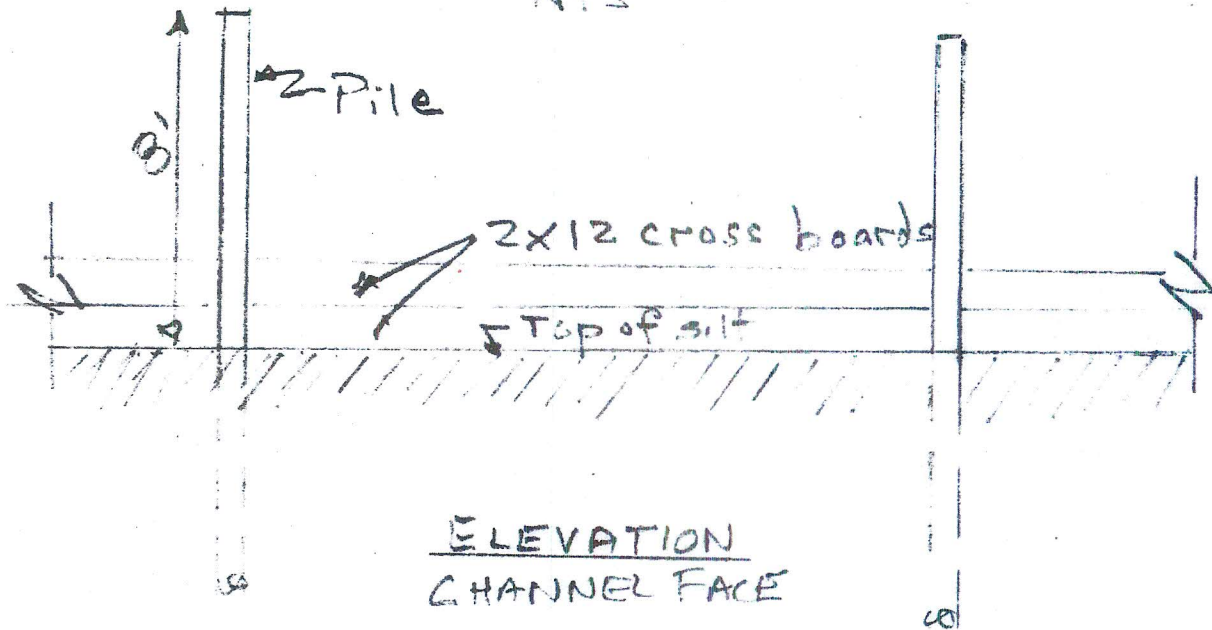

TYPICAL SECTION

TIMBER BREAKWATERS
TYPICAL DETAILS

Note: Details are for two 1500' breakwaters installed parallel to entrance channel on the north and south sides.

PROJECT	HARBOR WATERWAY ASSOC	Page ... of ...	COMPUTED BY	DATE
SUBJECT	MAINTENANCE DREDGING		CHECKED BY	DATE

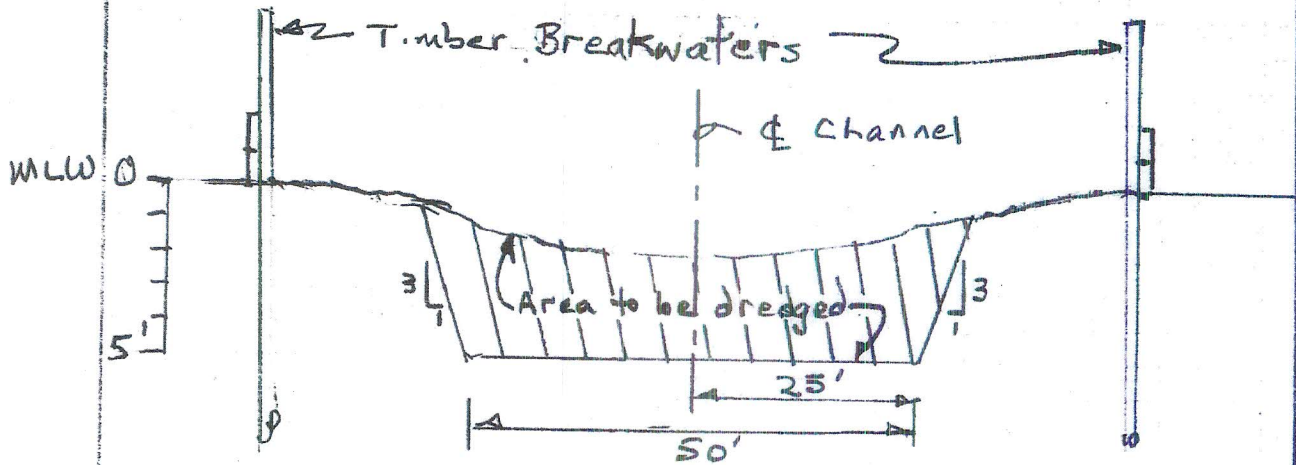

TYPICAL SECTION - APPROACH CHANNEL

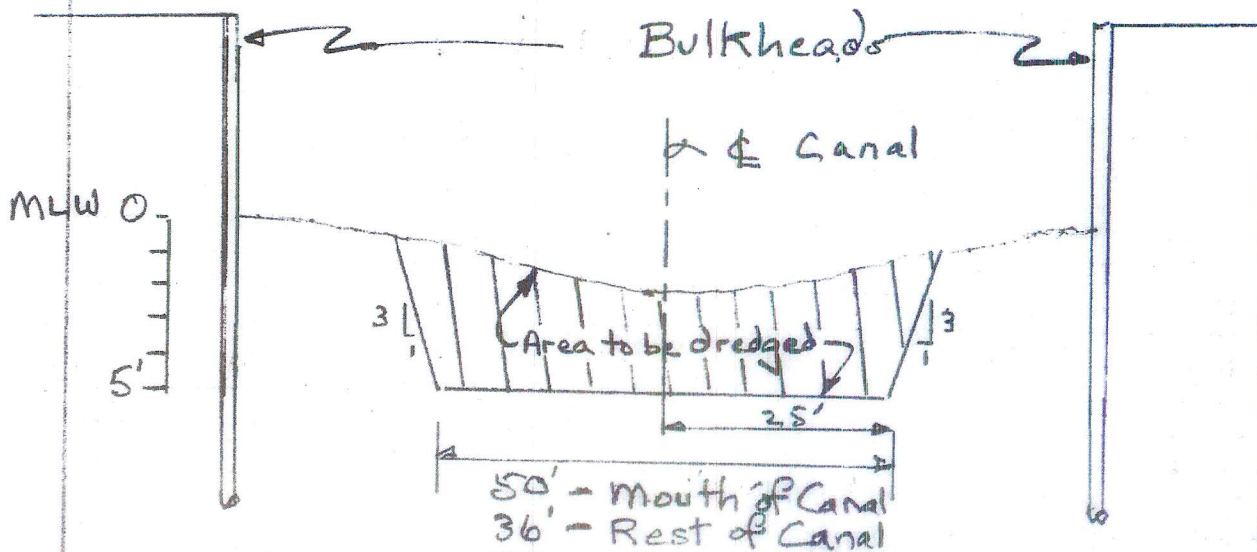

TYPICAL SECTION - CANAL

Channel No 1A

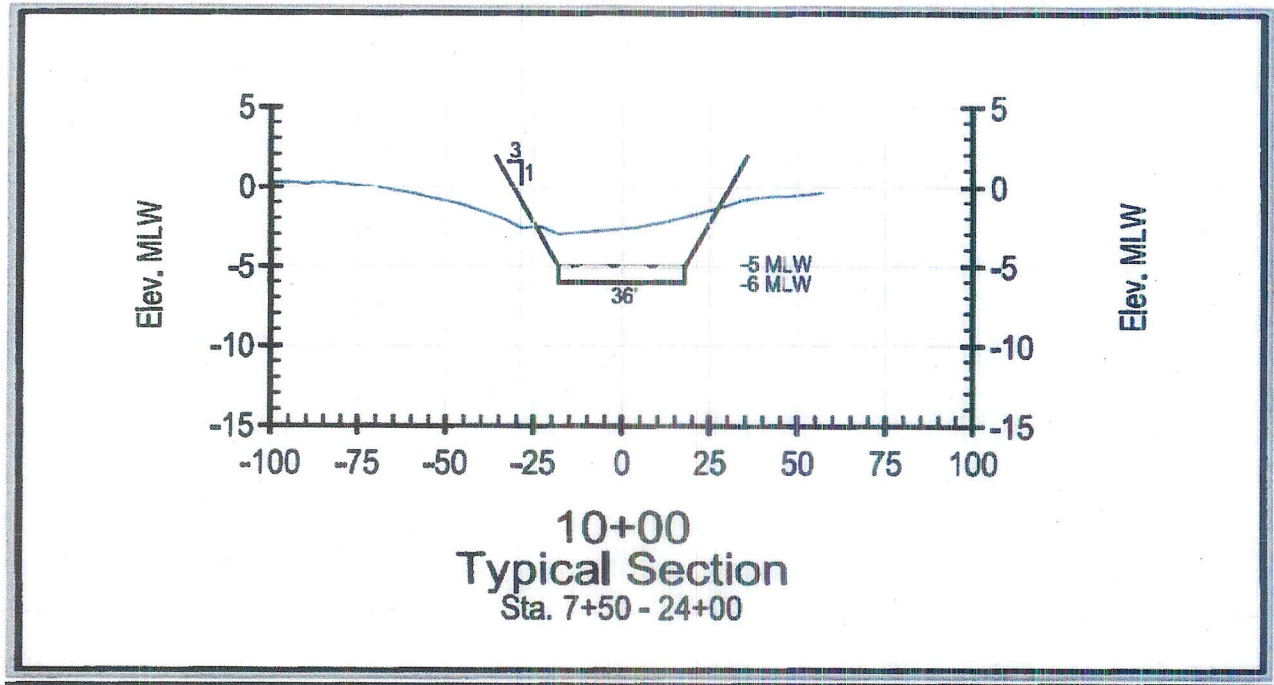

Channel No 1B

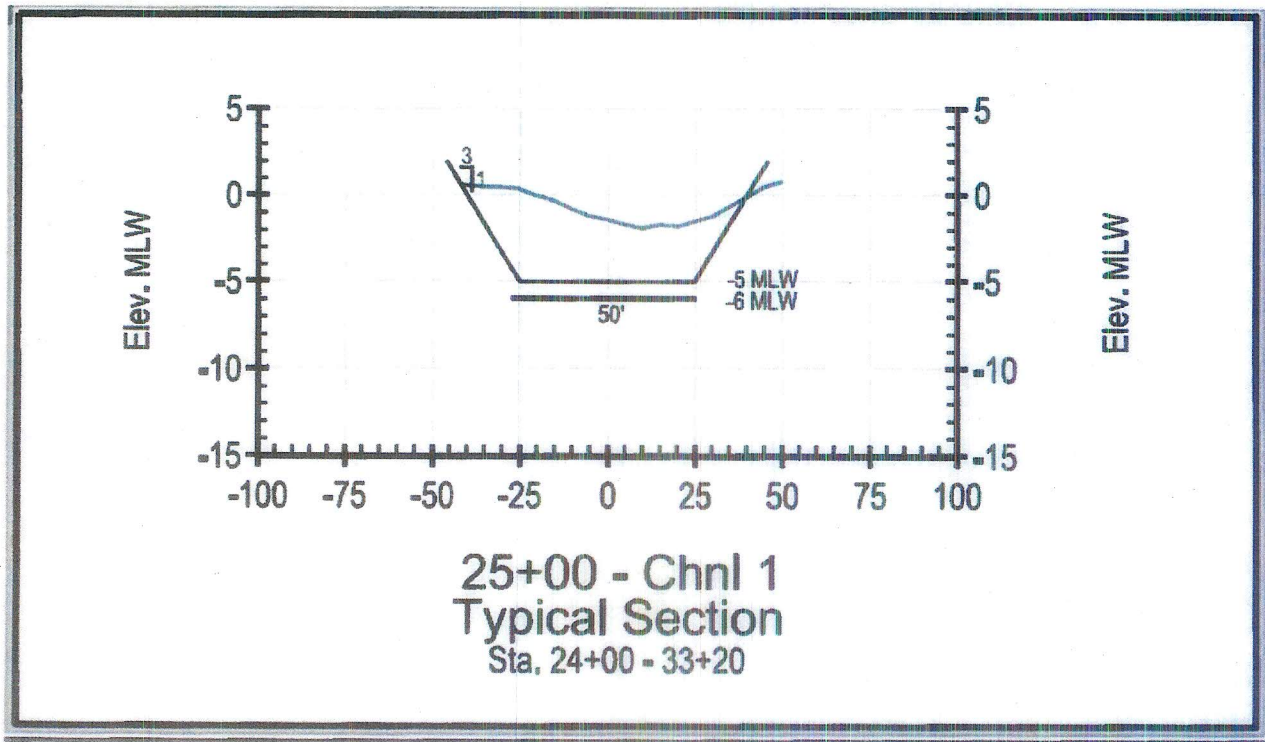

Channel 2A + B

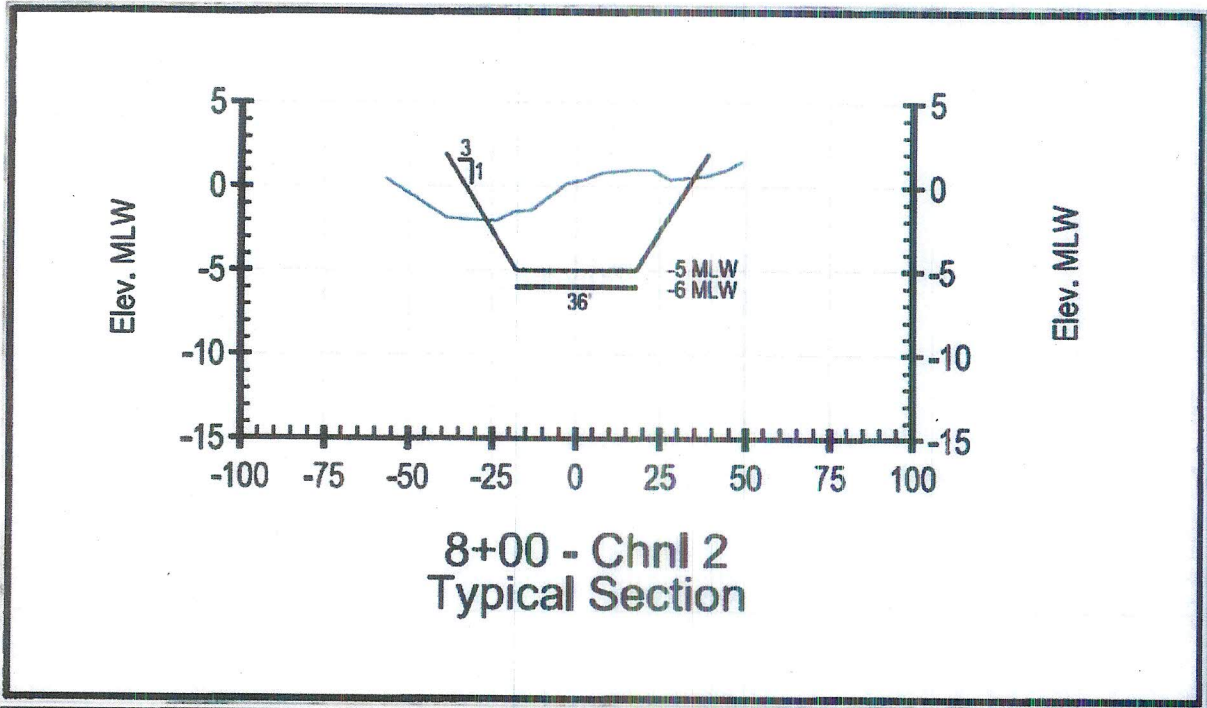

Channel 2C + D

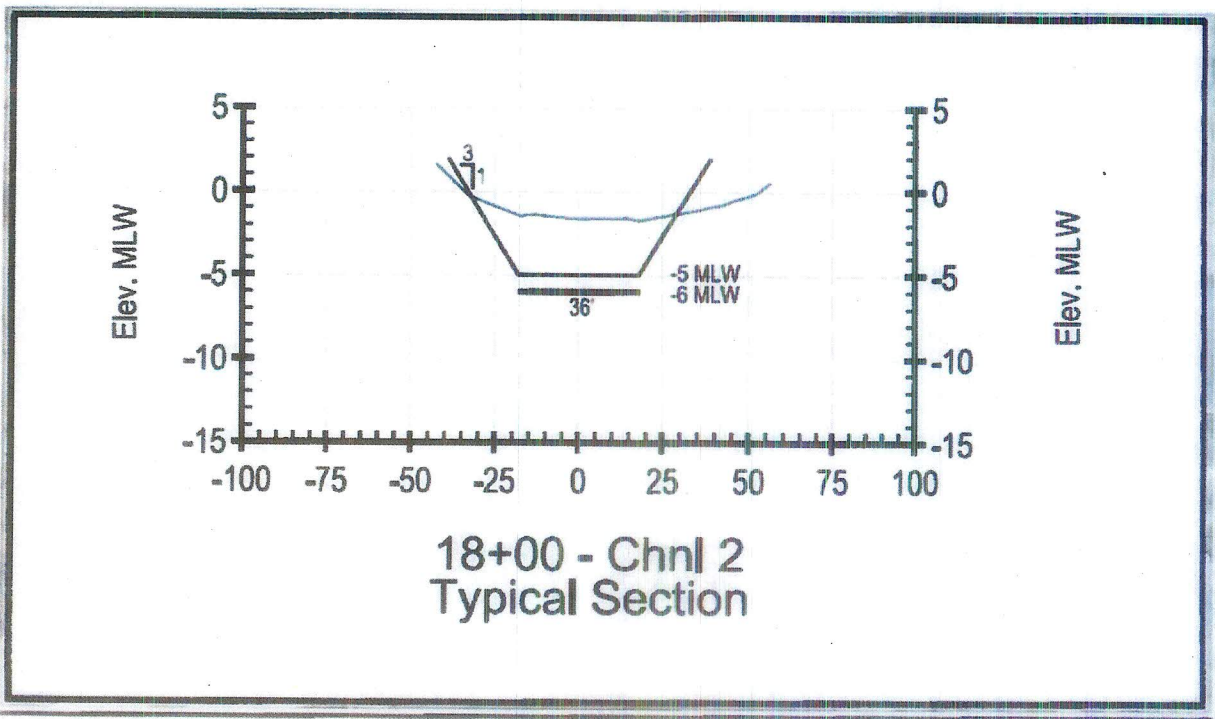

Channel 3A + B

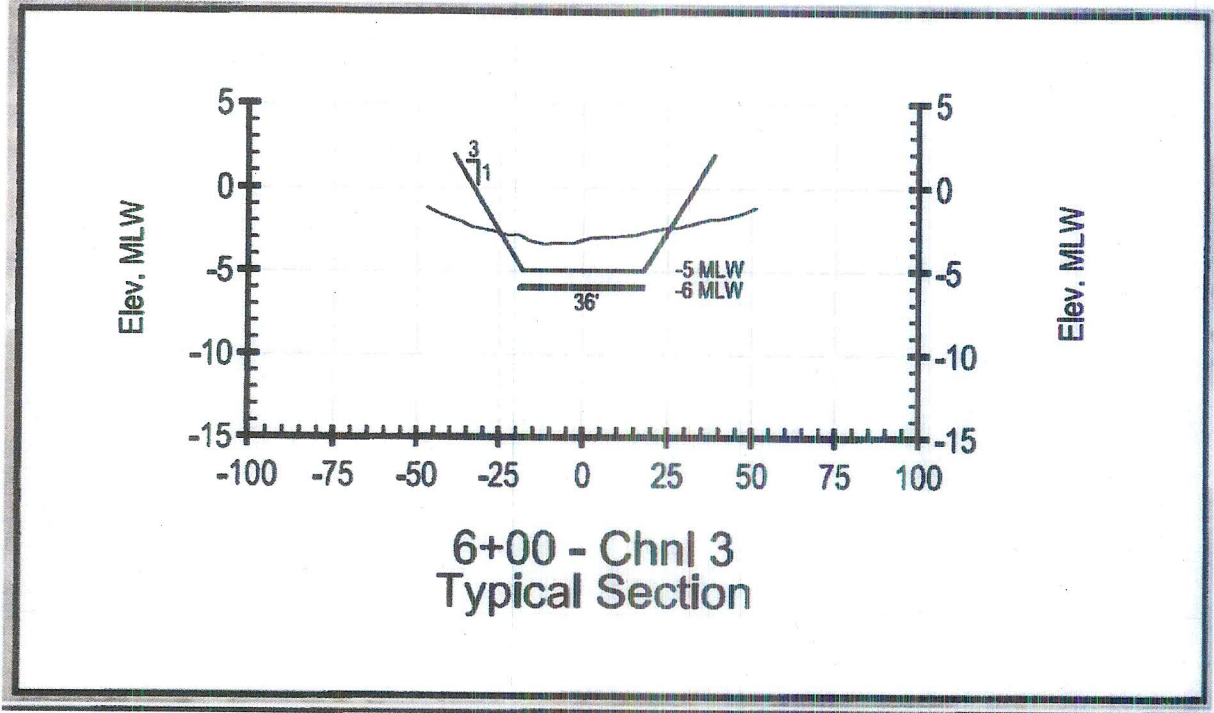

STANDARD MANATEE CONDITIONS FOR IN-WATER WORK

2011

The permittee shall comply with the following conditions intended to protect manatees from direct project effects:

- a. All personnel associated with the project shall be instructed about the presence of manatees and manatee speed zones, and the need to avoid collisions with and injury to manatees. The permittee shall advise all construction personnel that there are civil and criminal penalties for harming, harassing, or killing manatees which are protected under the Marine Mammal Protection Act, the Endangered Species Act, and the Florida Manatee Sanctuary Act.
- b. All vessels associated with the construction project shall operate at "Idle Speed/No Wake" at all times while in the immediate area and while in water where the draft of the vessel provides less than a four-foot clearance from the bottom. All vessels will follow routes of deep water whenever possible.
- c. Siltation or turbidity barriers shall be made of material in which manatees cannot become entangled, shall be properly secured, and shall be regularly monitored to avoid manatee entanglement or entrapment. Barriers must not impede manatee movement.
- d. All on-site project personnel are responsible for observing water-related activities for the presence of manatee(s). All in-water operations, including vessels, must be shutdown if a manatee(s) comes within 50 feet of the operation. Activities will not resume until the manatee(s) has moved beyond the 50-foot radius of the project operation, or until 30 minutes elapses if the manatee(s) has not reappeared within 50 feet of the operation. Animals must not be herded away or harassed into leaving.
- e. Any collision with or injury to a manatee shall be reported immediately to the Florida Fish and Wildlife Conservation Commission (FWC) Hotline at 1-888-404-3922. Collision and/or injury should also be reported to the U.S. Fish and Wildlife Service in Jacksonville (1-904-731-3336) for north Florida or Vero Beach (1-772-562-3909) for south Florida, and to FWC at ImperiledSpecies@myFWC.com
- f. Temporary signs concerning manatees shall be posted prior to and during all in-water project activities. All signs are to be removed by the permittee upon completion of the project. Temporary signs that have already been approved for this use by the FWC must be used. One sign which reads *Caution: Boaters* must be posted. A second sign measuring at least 8 ½" by 11" explaining the requirements for "Idle Speed/No Wake" and the shut down of in-water operations must be posted in a location prominently visible to all personnel engaged in water-related activities. These signs can be viewed at MyFWC.com/manatee. Questions concerning these signs can be sent to the email address listed above.

CAUTION: MANATEE HABITAT

All project vessels

IDLE SPEED / NO WAKE

When a manatee is within 50 feet of work
all in-water activities must

SHUT DOWN

Report any collision with or injury to a manatee:

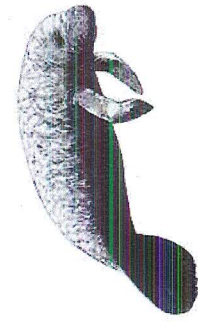

Wildlife Alert:

1-888-404-FWCC(3922)

cell *FWC or #FWC

SELF-CERTIFICATION STATEMENT OF COMPLIANCE

Permit Number: SAJ-1993-1030(SP-PRJ)

Permittee's Name & Address (please print or type): _____

Telephone Number: _____

Location of the Work: _____

Date Work Started: _____ Date Work Completed: _____

Description of the Work (e.g. bank stabilization, residential or commercial filling, docks, dredging, etc.): _____

Acreage or Square Feet of Impacts to Waters of the United States:

Describe Mitigation completed (if applicable): _____

Describe any Deviations from Permit (attach drawing(s) depicting the deviations):

I certify that all work, and mitigation (if applicable) was done in accordance with the limitations and conditions as described in the permit. Any deviations as described above are depicted on the attached drawing(s).

Signature of Permittee

Date